



BEATRICE R8

8 Channel Network Audio Intercom

PRODUCT DETAILS



6 BROOKS PLACE, MAIDSTONE, KENT, ME14 1HE. ENGLAND.
Visit our Website at www.glensound.com

TEL: +44 (0) 1622 753662
FAX: +44 (0) 1622 762330



GlenSound Electronics Ltd

Thank you for choosing a new GlenSound product.

All rights reserved.

Information contained in this manual is subject to change without notice, if in doubt please contact us for the latest product information.

If you need any help with the product then we can be contacted at:

GlenSound Electronics Ltd
1 – 6 Brooks Place
Maidstone
Kent
ME14 1HE
United Kingdom

Telephone: +44 (0) 1622 753662

Fax: +44 (0) 1622 762330

EMAIL ADDRESSES

General enquires: office@glenSound.co.uk

Technical enquires: techinfo@glenSound.co.uk

Sales enquires: sales@glenSound.co.uk

PRODUCT WARRANTY:

All equipment is fully tested before dispatch and carefully designed to provide you with trouble free use for many years.

We have a policy of supporting products for as long as possible and guarantee to be able to support your product for a minimum of 10 years.

For a period of one year after the goods have been despatched the Company will guarantee the goods against any defect developing after proper use providing such defects arise solely from faulty materials or workmanship and that the Customer shall return the goods to the Company's works or their local dealer.

All non-wear parts are guaranteed for 2 years after despatch and any defect developing after proper use from faulty materials or workmanship will be repaired under this warranty providing the Customer returns the goods to the Company's works or their local dealer.



SAFETY WARNING



This product can produce high sound levels via the headphone output.

Please take caution when operating this product as listening to excessively high peak or sustained levels of volume may permanently damage human hearing.



EU DECLARATION OF CONFORMITY FOR:

GS-BEATRICE R8

8 Channel Dante/ AES67 desktop intercom

This declaration of conformity is issued under the sole responsibility of the manufacturer.

This equipment is manufactured by Glensound Electronics Ltd of Brooks Place Maidstone Kent ME14 1HE is **CE** marked and conforms to the following Union harmonisation legislation:

Low Voltage Directive:	EN60065 and EN62368-1:2014
Emissions:	BS EN55032:2015
Immunity:	BS EN55035:2017

Signed for and on behalf of Glensound Electronics Ltd.

A handwritten signature in black ink, consisting of several loops and a long horizontal stroke, is positioned above the printed name of the signatory.

Gavin Davis, Managing Director
Maidstone, Kent, England

Date: 15/03/2018

RoHS DIRECTIVE

EC directive 2002/95/EC restricts the use of the hazardous substances listed below in electrical and electronic equipment.

This product conforms to the above directive and for this purposes, the maximum concentration values of the restricted substances by weight in homogenous materials are:

Lead	0.1%
Mercury	0.1%
Hexavalent Chromium	0.1%
Polybrominated Biphenyls	0.1%
Polybrominated Diphenyl Ethers	0.1%
Cadmium	0.01%

WASTE ELECTRICAL AND ELECTRONIC EQUIPMENT REGULATIONS 2006 (WEEE)

Glen sound Electronics Ltd is registered for business to business sales of WEEE in the UK our registration number is:

WEE/JJ0074UR

GLENSOUND BEATRICE R8

Handbook Contents

Issue 4

Description

Page No.

Contents

PRODUCT WARRANTY:.....	3
OVERVIEW	8
R8 FRONT PANEL LAYOUT	9
R8 REAR PANEL LAYOUT	12
MICROPHONE PHANTOM POWER	14
AUDIO BLOCK DIAGRAMS (analogue representation of digital circuits).....	15
Audio Circuits TO Dante/ AES67 Network <i>SEE ALSO FIXED MIXER</i>	15
Audio Circuits FROM Dante/ AES67 Network <i>SEE ALSO FIXED MIXER</i>	16
FIXED MIXER	17
CONNECTING TO 4-WIRE EQUIPMENT.....	18
CONNECTING THE BEATRICE UNITS TO A DANTE NETWORK	19
Getting Dante Controller.....	19
Connecting Beatrice To The Network	19
Audio Over IP Network.....	19
Running Dante Controller	20
Dante Controller TIP	20
Device Not Showing Up In Dante Controller	21
AES67 MODE	22
WIRING INFORMATION	25
XLR & JACK Wiring	25
D15 Socket Loop Input Wiring	26
D25 Plug Loop Output Wiring.....	27

OVERVIEW

The BEATRICE range of IP intercoms was designed for broadcast, theatre and professional audio applications.

Our Beatrice intercom system utilises the reliable and proven Dante™ network audio transmission protocol to allow real time distribution of uncompressed audio across standard networks. As such the BEATRICE 8 channel units are also fully compatible with other manufacturers' equipment using the Dante™ protocol. The Beatrice R8 is also AES67 compliant.

All units in the system are designed to be very easy to use for the operator and simple to setup for the technician. They includes all the basic functionality required for small intercom systems and none of the overly complex installation requirements normally associated with large systems.

The name Beatrice was chosen for our intercom range as she was the love of Dante Alighieri:

'Dante had fallen in love with another, Beatrice Portinari (known as Bice), whom he first met when he was only nine.' Source Wikipedia.

R8 FRONT PANEL LAYOUT

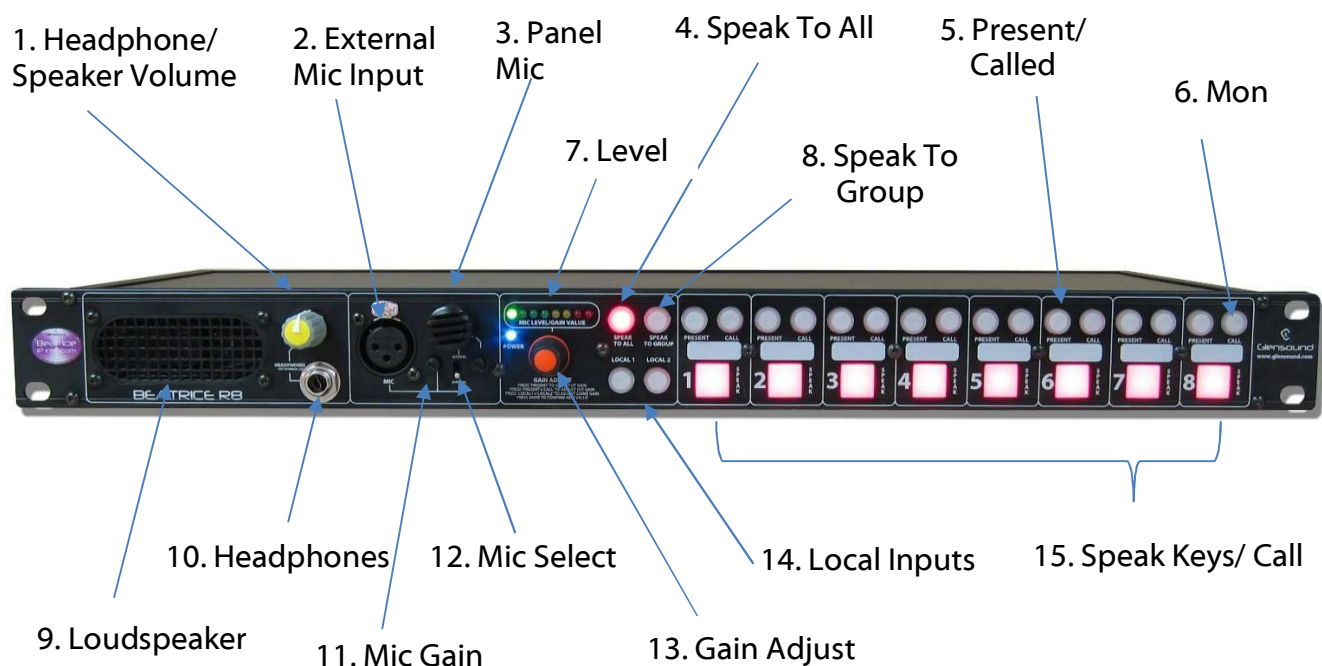

1. Headphone / Speaker Volume

This rotary knob adjusts the volume of the internal loudspeaker and front panel headphones.

2. External Microphone Input

This is a balanced microphone input. It can accept dynamic and condenser microphones and phantom power (12v) can be turned on/ off via an internal link.

3. Panel Microphone

The panel microphone is a small electret microphone fitted behind the rugged housing and is suitable for most communications purposes.

4. Speak to All Button

Pressing this button enables the operator to turn on and talk to all 8 outputs simultaneously.

5. Present/ Called Indicators

There are 8 present indicators one for each talkback input from the audio network. These are both a LED indicator and a button.

When an incoming audio signal is detected on the associated incoming circuit the present LED will illuminate (threshold -20dB) to show that audio is being

received on that channel. The present LED will stay illuminated for 10 seconds after the incoming audio stops.

The present LED is also used to indicate an incoming call from another device. If an incoming call is detected then the present LED will flash

Pressing the present indicator button allows the audio input level of that circuit to be adjusted using the front panel Gain Adjust knob.

6. **Mon Button**

This yellow button is used to select incoming circuits to route to the monitor (loudspeaker/ headphones).

If the switch is on and illuminated then the source is currently being monitored.

If none of these monitor buttons are on then the loudspeaker/ headphones will monitor a mix of all 8 incoming circuits.

7. **Level LEDs**

The level LEDs provide a number of functions.

- A) When the unit is first turned on The 2nd LED from the left will flash. This is a heartbeat signal indicating that internal processor is starting up. When it's started and ready the 2nd LED will stop flashing.
- B) The first LED from the left flashes if no network connection is present.
- C) When adjusting the input or output gain of one of the 8 channels or the input gain of the 2 local inputs then the LEDs are used to indicate the position of the volume control. With just 1 LED on on the left indicating a very low gain and all LEDs on indicating a very high gain. While in this mode the LEDs will be flashing to indicate that they are showing the gain position and not actual level.
- D) In all other circumstances the meter acts as a PPM to show the level being sent to the network from the selected microphone.

8. **Speak to Group**

The speak to group key is used to allow the operator to speak to a selection of outputs.

To make a group press and hold the Speak To Group key and simultaneously press a channel's talk key. Each time you press the channel's talk key the channel will be added/ subtracted from the group.

9. **Loudspeaker**

A front panel mounted loudspeaker for monitoring the incoming audio circuits. Note the loudspeaker is automatically turned off when a headphone jack is inserted into the headphone socket.

10. **Headphone Jack**

This standard 6.35mm (1/4") stereo headphone socket accepts headphones from 30 to 1000 Ohms.

11. **Mic Gain**

This rotary potentiometer adjusts the gain of the selected microphone.

12. **Mic Select**

This toggle switch selects which of the 2 microphones is to be used as the audio source. If the switch is in the up position then the panel mic is used and if the switch is in the down position the external microphone input is used.

13. **Gain Adjust**

This shaft encoder can be continuously rotated left and right and it also has a built in switch which is operated by pushing it.

It is used in conjunction with the Present, Present + Call or Local illuminated buttons to adjust the input (or output) gain of the associated channel.

When a channel has been selected to have its gain adjusted the Level LEDs will start to flash, showing the amount of gain currently being applied, where the first left LED indicates low gain and all the LEDs indicate maximum gain.

Once the desired amount of gain has been set then push the gain adjust shaft encoder to set this gain level.

14. **Local Inputs**

There are 2 'local' analogue inputs on the rear of the subrack. These are routed straight to the Dante/ AES67 network. Using the local input front panel button in conjunction with the gain adjust control allows the input level of these circuits to be adjusted.

15. **Speak/Call Key**

The 8 front panel speak keys allow the operator to talk to the 8 outgoing talkback circuits. These talk keys operate as 'intelligent' lever keys whereby:

- A) A quick short press of the button will toggle the circuit on/ off
- B) A long holding press of the button will only turn the output on while the button is being pressed.

The speak keys also double as call switches, whereby a double tap of the speak key will send a call signal to the network.

R8 REAR PANEL LAYOUT

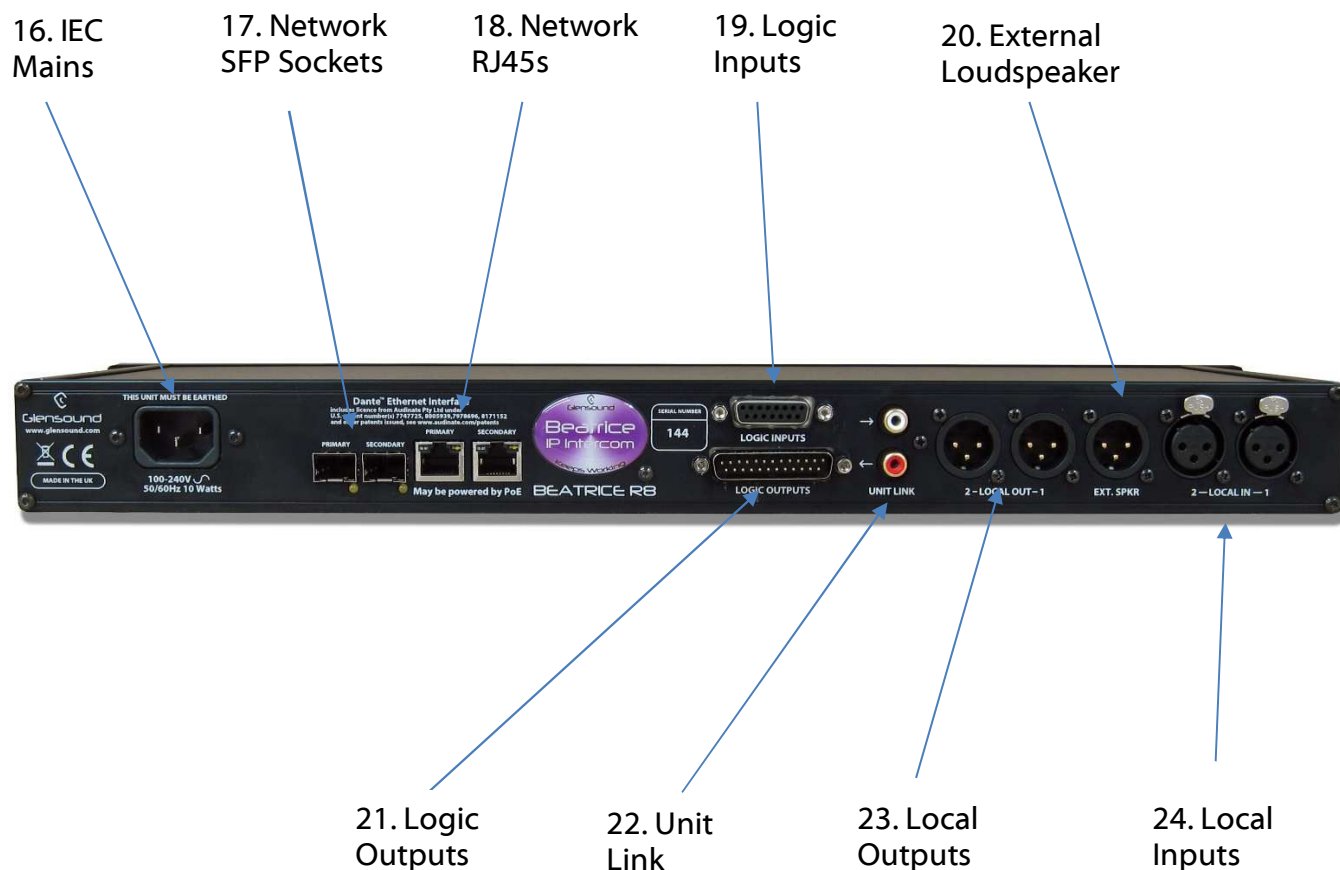

16. IEC Mains

The standard IEC mains plug accepts external AC voltages of 100 -240 VAC +/- 10%. There is an internal fuse.

17. Network SFPs

There are 2 standard network data SFP sockets provided to allow redundant network connectivity if using Dante network audio protocol. They are both gigabit network connections. They accept standard SFP modules. The status LEDs flash to show when data is being correctly communicated with the attached switch.

If you require SFP modules then please email sales@glensound.co.uk for a quotation.

Network Note (Applies to both 17 & 18)

Factory default is to have the SFP & RJ45 sockets set to work in redundant mode.

It is possible using Dante controller to set these network interfaces to work as a network switch instead of the redundant mode, meaning other network equipment can be connected to them.

18. **Network RJ45s**

There are 2 standard network data RJ45 sockets provided to allow redundant network connectivity if using Dante network audio protocol. They are both gigabit network connections. The status LEDs flash to show when data is being correctly communicated with the attached switch.

Either of network sockets can be connected to a Power Over Ethernet (PoE) source to power the subrack. This PoE source can be a mid-span source or a network switch with PoE. If a PoE source is present on both circuits then this will act as a redundant power supply.

19. **Logic Inputs**

This 15 pin 'D' connector socket provides connectivity to external switches or devices for remote control of the talk keys and also provides inputs for cutting the internal or external loudspeakers.

For further details see 'WIRING' at the rear of this manual.

20. **External Loudspeaker**

This is a standard balanced analogue audio output for connection to external loudspeaker amplifiers. The output level is adjusted by the front panel Loudspeaker Volume control.

21. **Logic Outputs**

This 25 pin 'D' connector plug provides outputs connected to solid state relays that are activated when either any one of the speak keys is on (ideal for connecting to external LS dim circuits) or individually when any call received circuit is activated.

For further details see 'WIRING' at the rear of this manual.

22. **Unit Link**

These two RCA phono connectors carry S/PDIF digital audio with embedded data designed to be able to link two R8 units together, allowing microphone, loudspeaker and integrated talk circuits to be shared between two R8 intercom units.

To connect two R8 units together then two off RCA phono cables are required. Each cable should be connected between the white output RCA socket on one subrack and the red input RCA socket on the other rack.

Please note it is not possible to connect more than two R8 racks together.

23. Local Outputs

These two line level analogue audio outputs are fed directly from two incoming circuits from the Dante/ AES67 network.

24. Local Inputs

These two line level analogue inputs are routed via gain controls to two network audio output circuits.

MICROPHONE PHANTOM POWER

The factory default configuration of the R8 has the front panel microphone input set as +12v phantom power on. It is possible to deactivate or activate +12v phantom power by moving an internal jumper.

To turn on phantom power the lid of the unit must be removed.

Please make sure the unit is turned off before starting this procedure

To do this remove one of the sides of the unit, which is held in place by 4 screws (2 at the front & 2 at the rear). Then slide the lid out to the open side. You can then access the jumper shown in the 2 pictures below.

Jumper for Phantom Power OFF

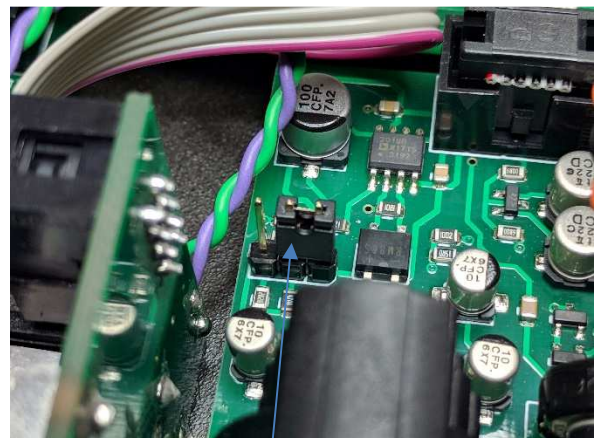
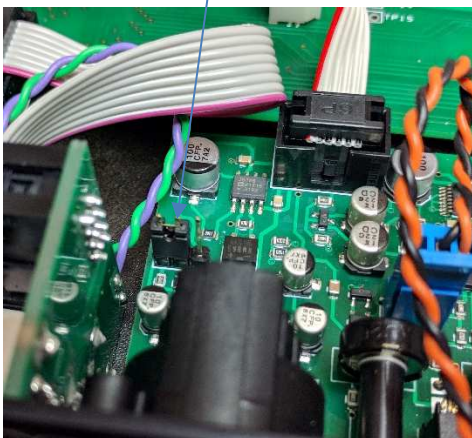

Jumper for Phantom Power ON

After turning the phantom power on or off please replace the lid and re-fix the side panel.

AUDIO BLOCK DIAGRAMS (analogue representation of digital circuits)

Audio Circuits TO Dante/ AES67 Network *SEE ALSO FIXED MIXER*

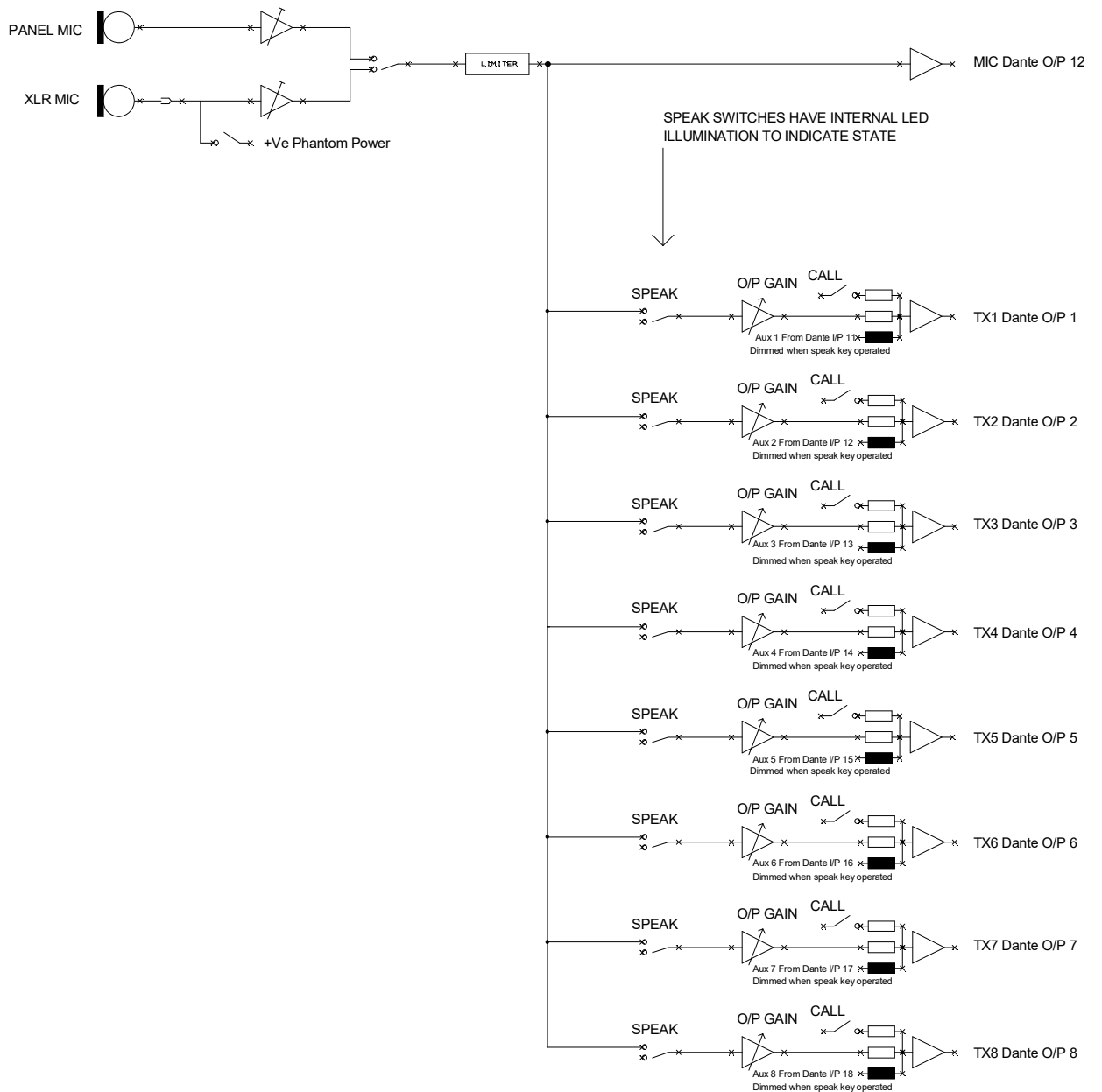
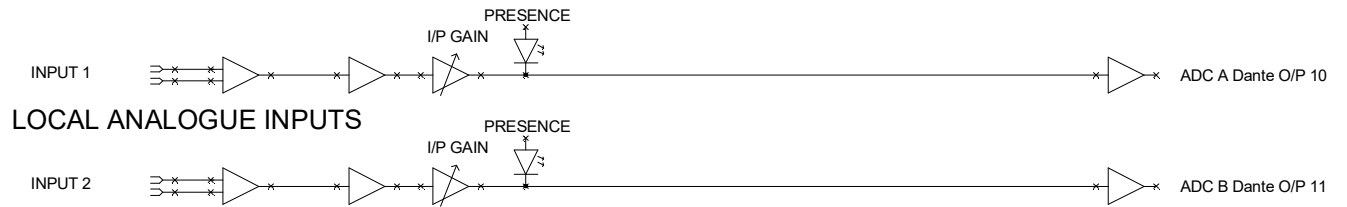

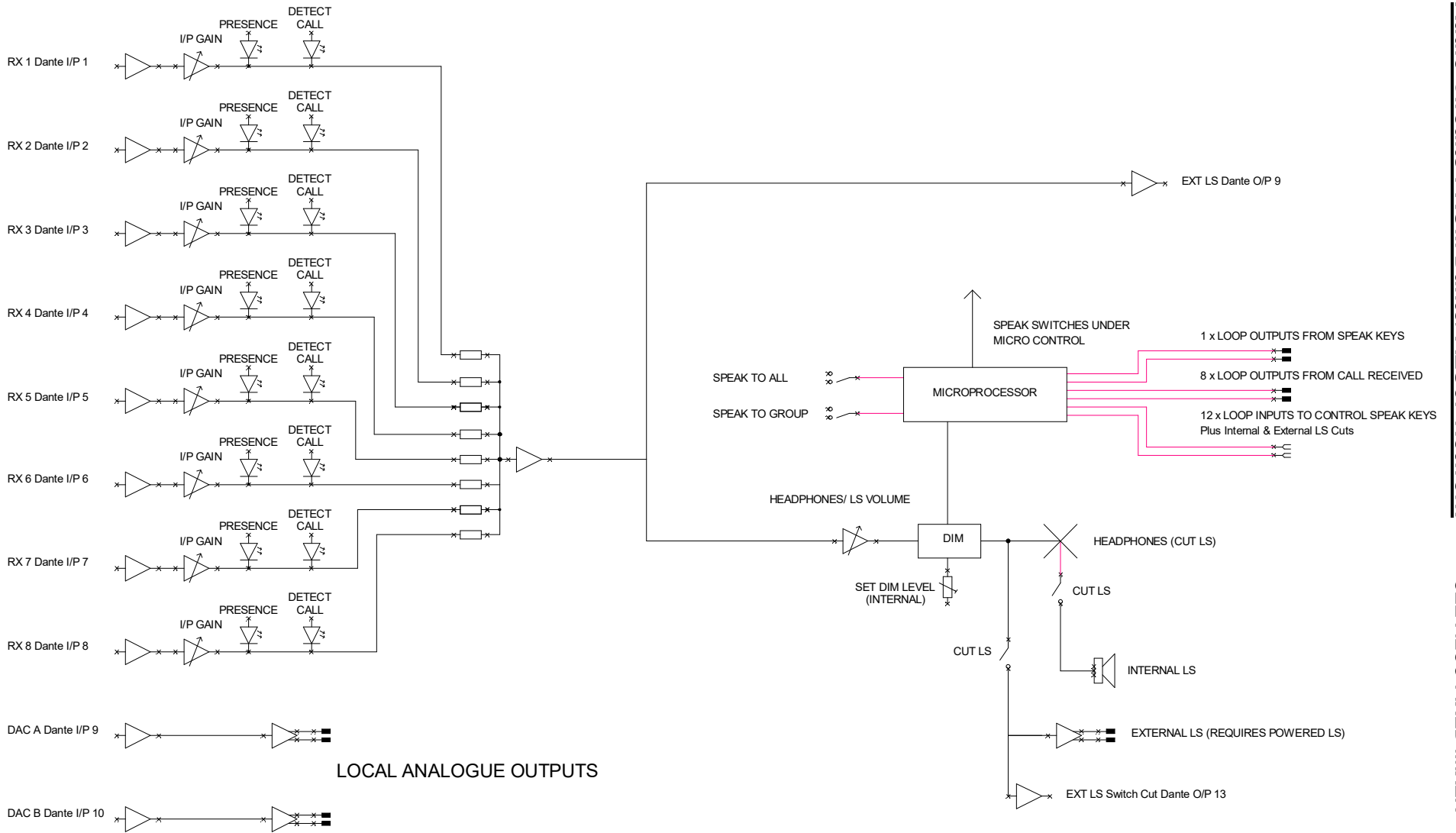

FIXED MIXER

The Beatrice R8 includes multiple fixed ratio mixers with inputs & outputs directly on/off the Dante/ AES67 network.

In a small simple intercom system there may be requirements for one user to listen to multiple sources on one single talkback channel. The internal fixed mixer within the Beatrice R8 is suitable for setting this up.

Groups are another possible requirement in small intercom systems whereby 2 or 3 operators (such as cameramen) are normally all on one single talkback circuit. The internal fixed mixer also helps with setting these circuits up.

The below table shows how these fixed ratio mixers are configured internally in the DSP. To use one or more of the internal mixers just route the audio to/ from the mixer channels in Dante controller.

Note that the default name in Dante Controller of the receivers are 'Mix In X' (whereby X is the channel number)

MIX OUTPUT		SUM OFF	NOTES
<i>Dante Output Channel No:</i>	<i>Default Name in Dante Controller:</i>	<i>Dante Receiver Channel Nos:</i>	
14	"Sum of 19 to 32"	19 to 32	
15	"Sum of 19 to 25"	19 to 25	
16	"Sum of 26 to 32"	26 to 32	
17	"Sum of 19 to 21"	19 to 21	
18	"Sum of 22 to 24"	22 to 24	
19	"Sum of 25 to 27"	25 to 27	
20	"Sum of 28 to 30"	28 to 30	
21	"Sum of 19 & 20"	19 and 20	
22	"Sum of 21 & 22"	21 and 22	
23	"Sum of 23 & 24"	23 and 24	
24	"Sum of 25 & 26"	25 and 26	
25	"Sum of 27 & 28"	27 and 28	
26	"Sum of 29 & 30"	29 and 30	
27	"Sum of 31 & 32"	31 and 32	
28	"Sum of 19 & 20 Dim"	19 and 20	Note Mix in 19 dimmed when signal present on Mix in 20
29	"Sum of 21 & 22 Dim"	21 and 22	Note Mix in 21 dimmed when signal present on Mix in 22
30	"Sum of 23 & 24 Dim"	23 and 24	Note Mix in 23 dimmed when signal present on Mix in 24
31	"Sum of 25 & 26 Dim"	25 and 26	Note Mix in 25 dimmed when signal present on Mix in 26
32	"Sum of 27 & 28 Dim"	27 and 28	Note Mix in 27 dimmed when signal present on Mix in 28

CONNECTING TO 4-WIRE EQUIPMENT

The Beatrice R8 can be interfaced to a maximum of two traditional 4-wire systems.

To do this it is necessary to utilise the local audio inputs & local audio output circuits on the R8 and route these to/ from one of the talkback channels via the audio over IP network.

Example to make Talkback Channel 8 operate as a 4 wire circuit.

- A) In Dante controller route local input 1 (Dante transmitter no 10) to Dante receiver no 8 (the audio input to channel 8)
- B) In Dante controller route Talkback 8 output (Dante transmitter no 8) to Dante receiver no 9 (local output 1)

CONNECTING THE BEATRICE UNITS TO A DANTE NETWORK

The Beatrices are network audio devices utilizing the reliable and versatile Dante audio over IP protocol. Dante is a proprietary system (although very widely used) the originators of which are Audinate.

The information below is only meant as a very basic guide. Full details of the power of Dante network audio and instructions for using it can be found at

www.audinate.com

Getting Dante Controller

If you are connecting the Beatrice to a new Dante network the first thing you will need to do is to get the free Dante controller software from Audinate.

This can be downloaded by visiting Audinate's web site at www.audinate.com

Connecting Beatrice To The Network

Beatrices can be connected to the network that you are going to use for your audio distribution simply by plugging in either, and, or any of the network connections on the rear. Once connected to the network it will be possible to see the Beatrice from within the Dante controller and route its' audio circuits.

Audio Over IP Network

We strongly recommend that you consider your network topology carefully and would not recommend sharing broadcast audio and general data on the same network.

For more details of audio over IP network structure please visit www.audinate.com

Running Dante Controller

At the time of writing this manual the Dante Controller looks as per the screenshot below:

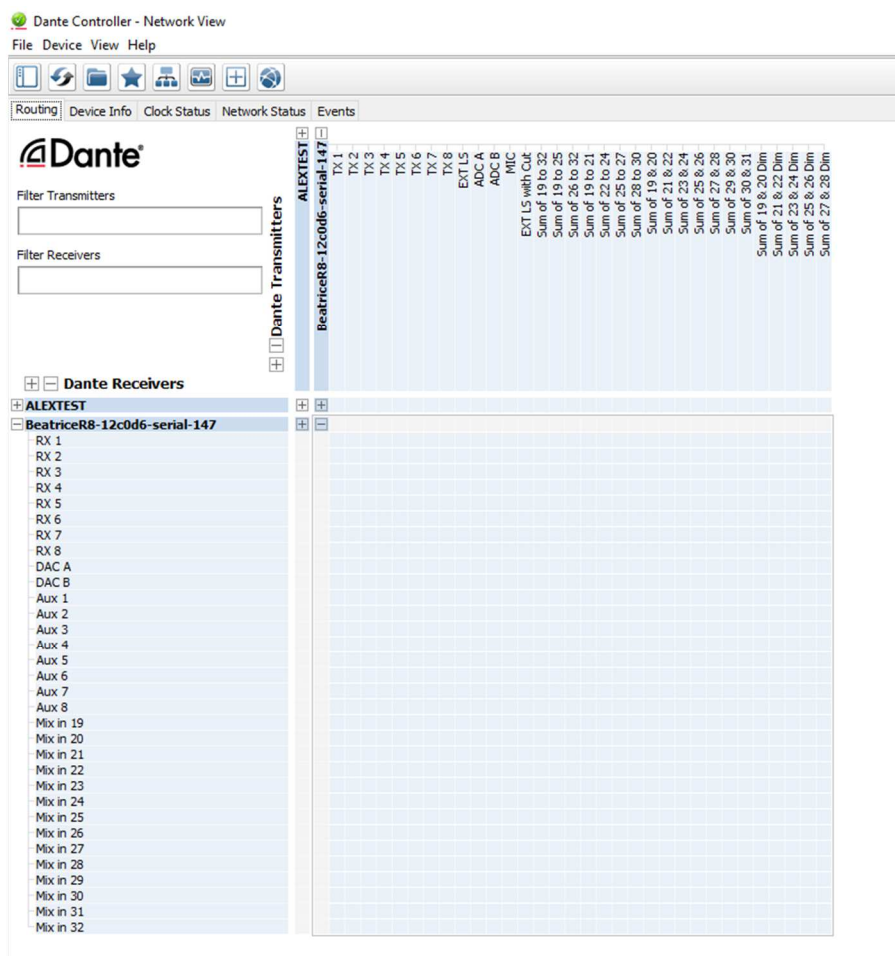

The Beatrice will have been named at the factory during test to allow them to be identified by the Dante controller.

The format used for the factory name is:

'BeatriceR8-ob7a2c-serial-125'

Where 'BeatriceR8-ob7a2c' refers to the Glensound product i.e. BeatriceR8 and its MAC address.

The '-serial-125' refers to the serial number of the BeatriceR8 which can be found printed on the rear or side of the unit.

Dante Controller TIP

If you have never run Dante controller before then make sure that on the bottom left of the Dante controllers' screen 'P' or 'S' is next to a green square as this indicates that it is connected to a network. By clicking 'P' or 'S' a pop up box opens to allow you to set what network interface the controller is using.

Device Not Showing Up In Dante Controller

If your Dante™ device does not show up in Dante™ Controller then the most likely issue is that the device's IP Address is not appropriate for your network.

- A) It maybe that the device is set to obtain an IP address automatically using DHCP (this is the default configuration) and your network is setup for fixed IP addresses only and does not have a DHCP server.
- B) It maybe that the device has had a fixed IP address assigned but that this address is not suitable for your network.

The solution to both scenarios is basically the same.

- 1) You must connect your Dante™ device directly to the Ethernet port of your computer using an Ethernet cable.
- 2) Make sure that your computer is set to 'Obtain an IP address automatically'
- 3) After a few minutes the Dante™ device should now appear in Dante™ Controller.
- 4) Double click the device name to open up device view.
- 5) Open up the 'Network Config' tab
- 6) Either turn on 'Obtain an IP Address Automatically' or correctly configure the 'Manually configure an IP Address' options for your network.
- 7) Click on 'Apply' to confirm the new settings, then disconnect the computer and reconnect the Dante™ device to your network.

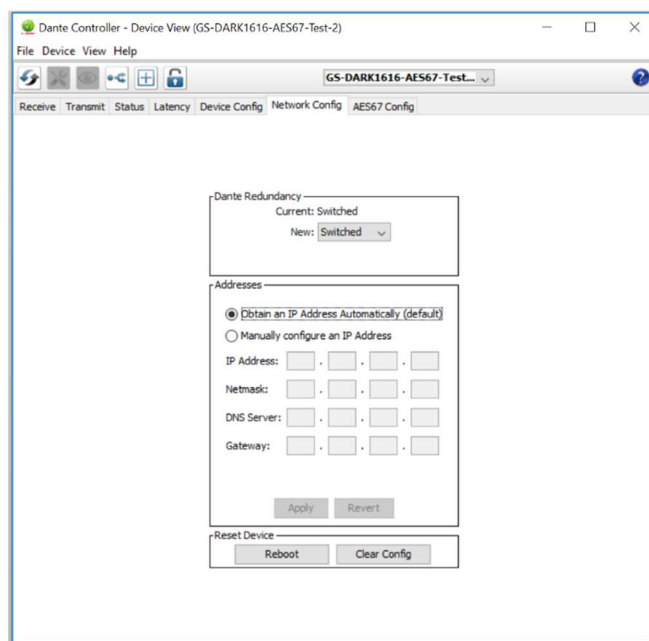

AES67 MODE

The Beatrice uses a module from Audinate called a Brooklyn Module for its network audio interface. Audinate are the company behind Dante™ and as such the module's primary network audio protocol is Dante, however Audinate have enabled their module to comply with AES67 and therefore the Beatrice can be set to AES67 mode for interaction with other AES67 devices.

Please note however that Glensound are relying on Audinate's AES67 interface and are unfortunately not able to provide full AES67 support for the unit. AES67 support should be sought directly from Audinate.

1. Turning On AES67 Mode

If you want to use your Beatrice on an AES67 network and it has not been set to AES67 mode then this can be set in Dante controller by double clicking the Paradiso to open the Device View window where you will find an AES67 tab to enable AES67 support.

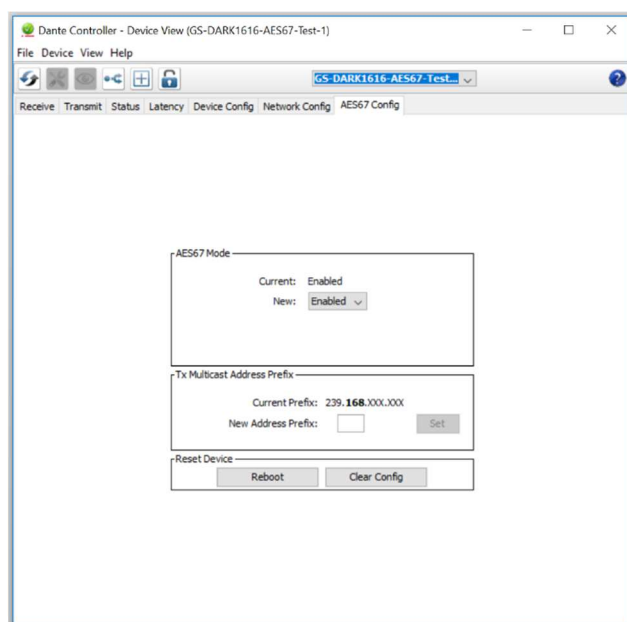

Once the AES67 drop down box has been enabled you'll have to reboot the Beatrice for the change to take effect. After the reboot go back to the AES67 tab and set the multicast prefix address to one that is suitable for your network.

2. Sending AES67 Audio

To transmit AES67 audio to the network a multicast flow must first be setup.

This is done by selecting the 'Create New Multicast Flow' Icon  in the Device View.

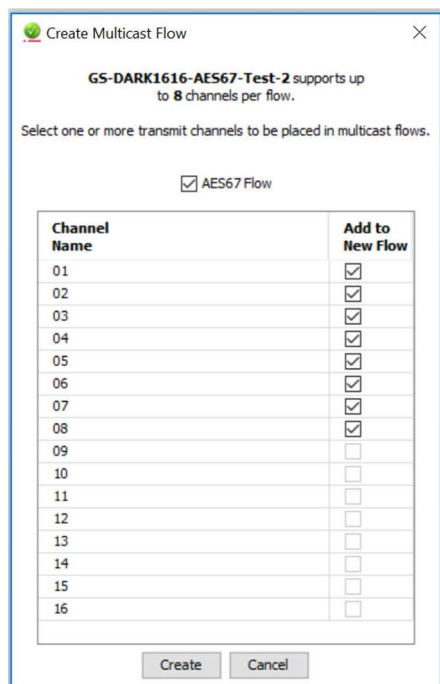

Tick the AES67 Flow check box, then select up to 8 channels to be included in the flow then click 'Create'

Once set the flows can be seen in the transmit tab of the device view.

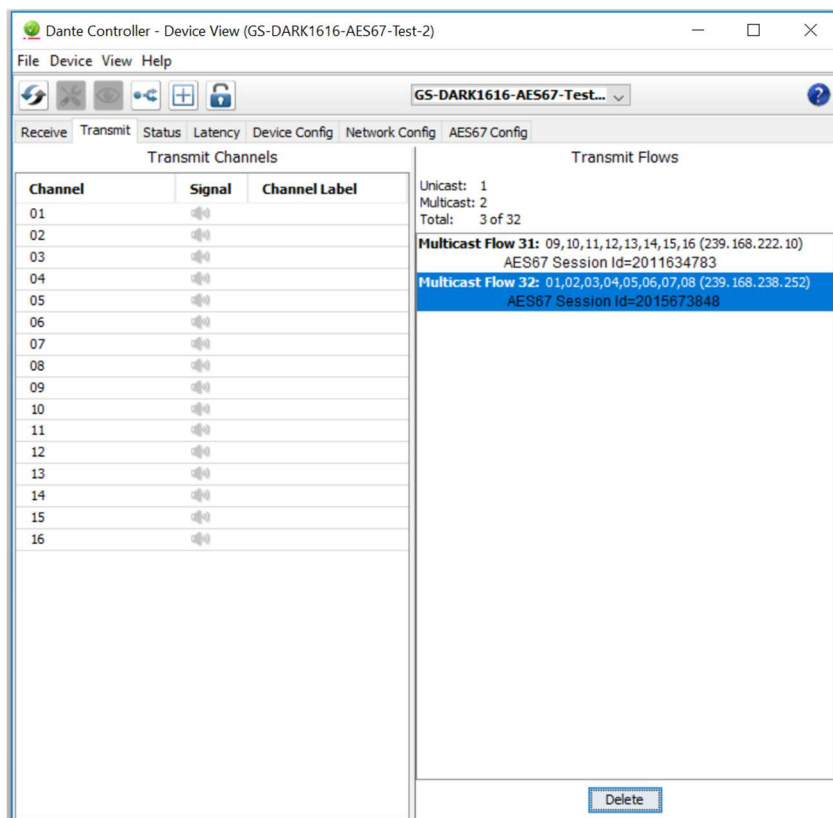

3. Receiving AES67 Audio

Once a compatible AES67 stream is detected on the network by Dante Controller the AES67 flows will appear in the Dante Transmitters section in the Routing tab.

4. AES67 Restrictions

AES67 flows can only be generated with the following constraints:

- Multicast Only
- Non-redundant
- Destination address in range 239.nnn.0.0 to 239.nnn.255.255 (239.nnn/16), port 5004
- 48kHz sampling rate
- 24 bit linear (L24) encoding
- 1 msec packet time
- Up to 8 channels per stream

Received AES67 flows have the following constraints:

- Multicast Only
- Non-redundant
- Destination address in range 239.nnn.0.0 to 239.nnn.255.255 (239.nnn/16), port 5004. Must match destination address range.
- 48kHz sampling rate
- L16 or L24 encoding
- 125usec, 250usec, 333usec, 1 msec packet time
- Up to 8 channels per stream

WIRING INFORMATION

XLR & JACK Wiring

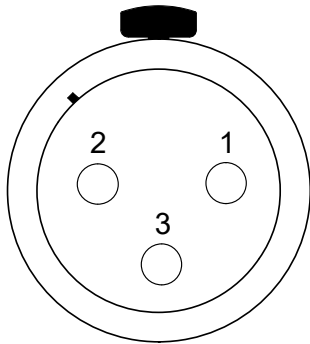

XLR SOCKET (FEMALE)

STANDARD XLR AUDIO PINOUTS:

1: Ground/ Earth

2: INPHASE/ POSITIVE/ MIC +

3: MATE/ NEGATIVE/ MIC -

STANDARD HEADPHONE WIRING:

TIP: A/ LEFT Ear

RING: B/ RIGHT Ear

SLEEVE: Common/ Earth

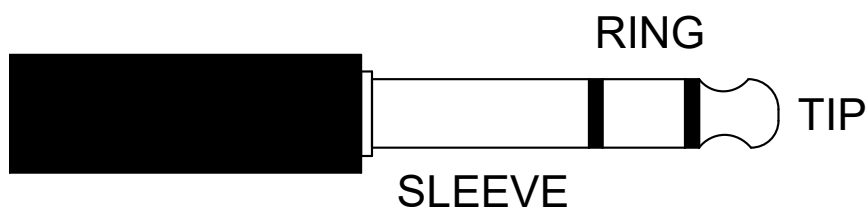

D15 Socket Loop Input Wiring

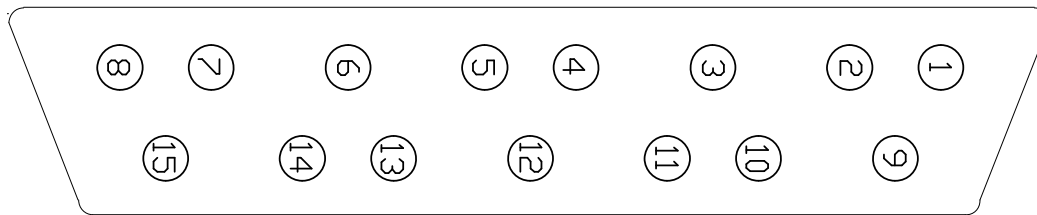

PIN Number	Function
1	Speak 1 Button
2	Speak 2 Button
3	Speak 3 Button
4	Speak 4 Button
5	Speak 5 Button
6	Speak 6 Button
7	Speak 7 Button
8	Speak 8 Button
9	Speak to Group
10	Speak to All
11	Cut Internal LS / HP Out
12	Cut EXT SPKR Out
13 - 14	Not connected
15	Ground/ Earth

The 12 active loop input pins work in Parallel with the front panel switches.

To operate an external loop just connect the input that you want to operate to the Ground/ Earth.

D25 Plug Loop Output Wiring

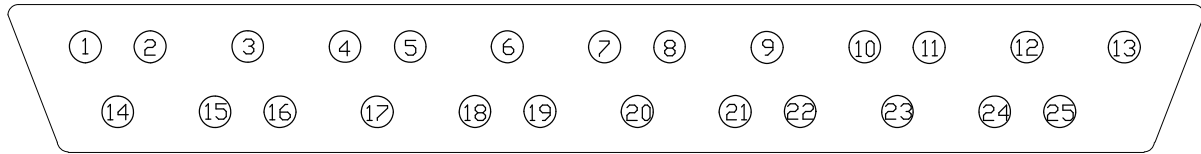

PIN Numbers	Function
1 & 14	Call Received Channel 1
2 & 15	Call Received Channel 2
3 & 16	Call Received Channel 3
4 & 17	Call Received Channel 4
5 & 18	Call Received Channel 5
6 & 19	Call Received Channel 6
7 & 20	Call Received Channel 7
8 & 21	Call Received Channel 8
12 & 25	Speak Key On
13	Ground/ Earth
9, 10, 11, 22, 23 & 24	Not Connected

Loop outputs are connected internally to solid state relays which are wired normally open. Therefore the PIN Numbers in the above table refer to either side of the switched relay output that will become joined together if the associated output is active.

The maximum voltage handling for each relay is 400V.

The maximum current handling for each relay is 100mA.